



CHENG YAO
Precision Technology co., LTD

- ◆ 光學鍍膜/模組設計開發
Optical Coating /
Module Design and Development.
- ◆ 金屬/塑膠零件 精密加工
Metal/Plastic Parts
Precision Machining.
- ◆ 真空腔體/管路 焊接製造
Vacuum Chamber / Pipe Welding
Manufacturing.
- ◆ 半導體設備 移機/調機
Semiconductor Equipment
Relocation / Tuning.

Creating Value
Driving Growth
創造價值 驅動成長

程躍精密科技成立於2015年，初期以開發設計為業務核心，後因應客戶開發時程縮短與保密需求，遂於本廠導入自動化精密加工設備，並自主訓練專業人才，達到設計與生產的整合，以提供給客戶迅速且穩定的自動化機械設備改造服務。

而近年因國內半導體擴廠的動能，國際大廠設備增加，本公司承接到日本東京威力(TEL)在南科機台的裝機/測試業務。經過TEL本社的培訓，以及自主的團隊內訓下，同仁皆通過TEL認證，並取得ML資格。

本公司也提供真空腔體 / 管路 / 氣體管路(BA)焊接等工程業務，為客戶提供更全面的專業服務。

Established in 2015, **Cheng Yao Precision Technology** initially focused on development and design as our core business. However, in response to shortened development schedules and confidentiality requirements from our clients, we introduced automated precision machining equipment into our facility. We also conducted in-house training to cultivate a team of professionals, enabling the integration of design and production to provide rapid and reliable automation machinery retrofitting services to our clients.

In recent years, driven by the expansion of domestic semiconductor facilities and increased equipment from international corporations, we have undertaken installation and testing projects for Tokyo Electron Ltd (TEL) in the Southern Taiwan Science Park. Our team successfully completed training provided by TEL headquarters and obtained ML certification.

We also offer engineering services such as welding for vacuum chambers, piping, and gas piping (BA), providing our clients with comprehensive and specialized solutions.

chengyao.com.tw



光學鍍膜設備模組

Optical Coating Equipment Module

本公司專營鍍膜設備模組開發/改造，
具備多年實務經驗，北中南皆有客戶實績
是您改善良率、提升稼動率的最佳幫手。

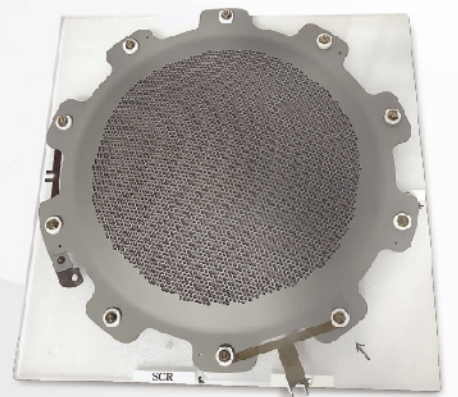
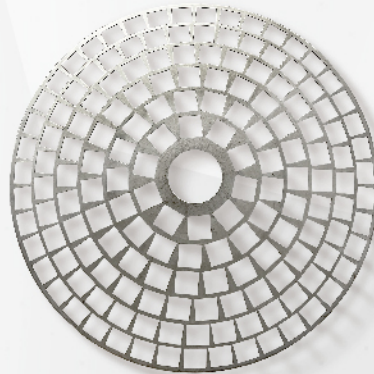
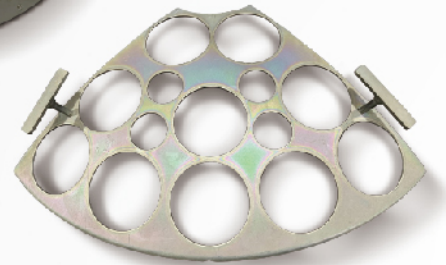
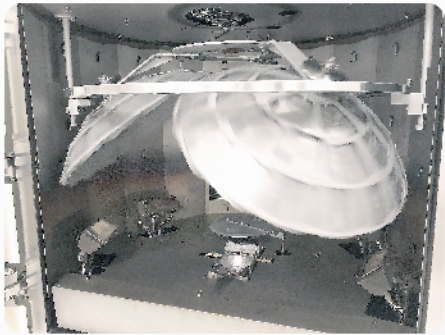

模組設計開發

Module Design and Development

專攻半導體設備自動化及承載模組開發
Specializing in Semiconductor Equipment Automation
and Wafer Carrier Module Development

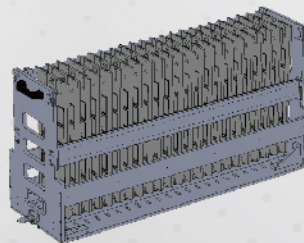
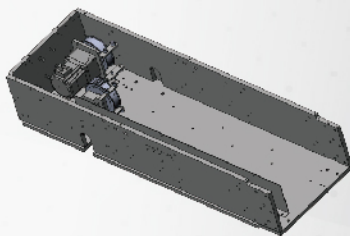
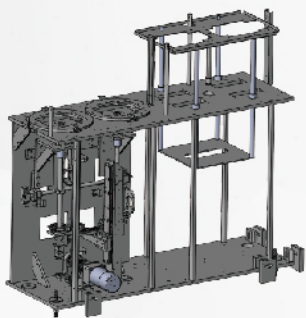

程曜精密科技有限公司
Cheng Yao precision technology co., LTD

+886-6-2451326

Alan.W@chengyao.com.tw

台南市安南區本原街一段262巷16號



真空腔體

Vacuum Chamber

專用於光學鍍膜設備之真空腔體開發及生產

Development and Production of Vacuum Chambers Specifically Designed for Optical Coating Equipment

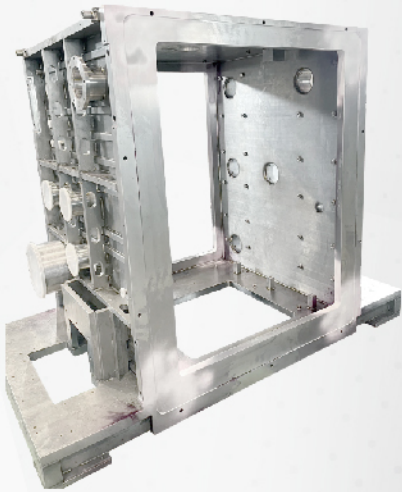
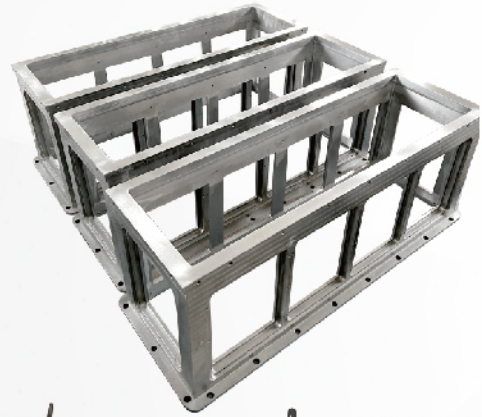

滲透探傷法Liquid Penetrant Testing / LPT

半導體設備裝機 / 調機

Semiconductor Equipment Relocation / Tuning.

承接日商半導體設備在台裝機



程曜精密科技有限公司
Cheng Yao precision technology co., LTD

☎ +886-6-2451326
✉ Alan.W@chengyao.com.tw
📍 台南市安南區本原街一段262巷16號



精密加工

Precision Machining

各式治具
Jigs

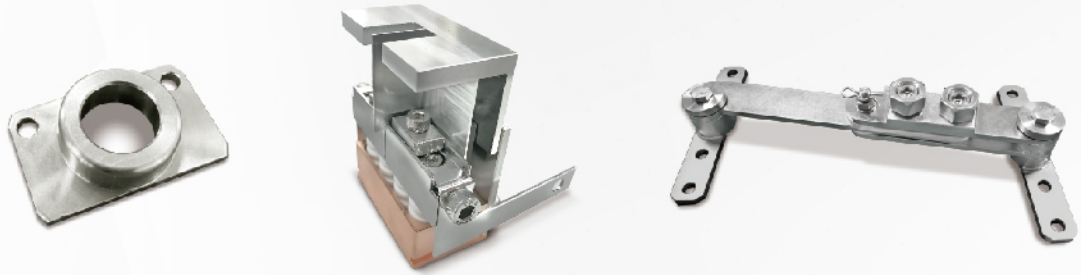

載具
Holder

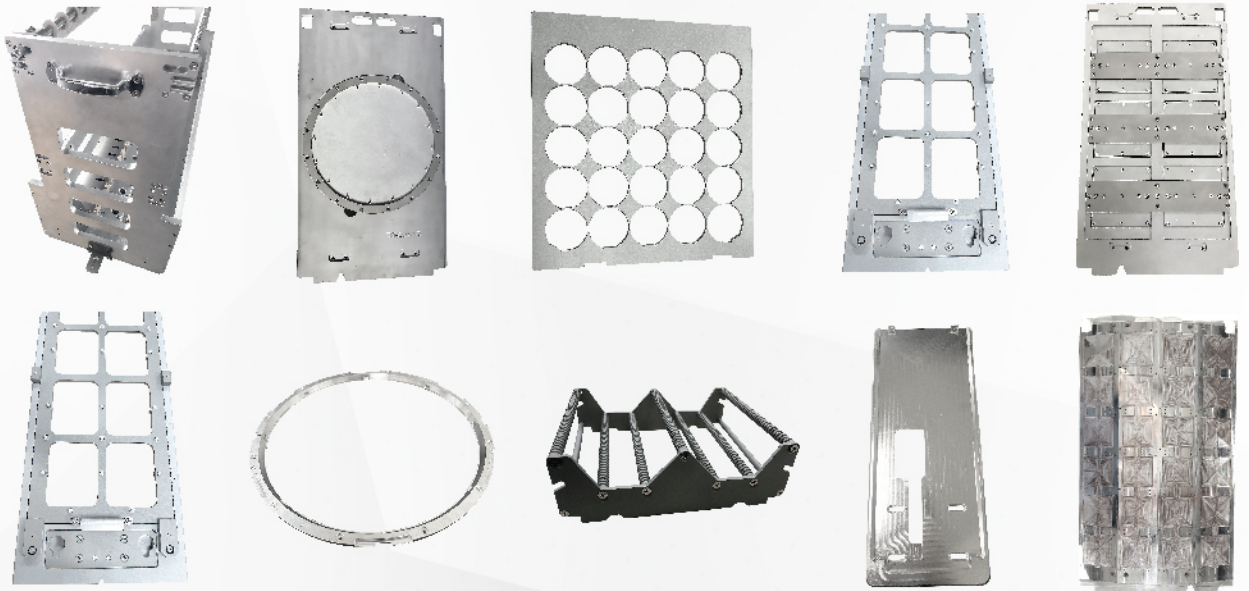

特殊表面處理【鋁熔射 / 陶瓷熔射 / 陽極處理】

Surface Finishing【Aluminum Thermal Spray Coatings / Ceramic Thermal Spray Coating / Anodizing】



特殊材質

Special Material【Peek / POM / Ceramic / PTFE / MC Nylon】

